

Ex i Solenoid Operator Type 1262

Operating Instructions



Dear Customer!

In order to guarantee the function and for your own safety, please read the enclosed operating instructions attentively before starting installation. Should there still arise any question or queries, please contact nass magnet GmbH.

Phone ++49 (0) 511 6746-0
Fax ++49 (0) 511 6746-222
e-mail vertrieb@nassmagnet.de

General Conditions

- We are not liable for any damage caused by non-observation of this information as well as in case of improper intervention regarding this device. Furthermore, warranty for the devices and accessories will become void.
- The EC type-examination certificate exclusively covers solenoid operators with nass magnet armature assembly and with nass magnet solenoid coil; please consider the corresponding power levels.
- In its installed state the device is certified for equipment protection by **intrinsic safety "i"** for potentially explosive gas atmospheres or dust atmospheres of Group IIB, IIC or IIIC with an ignition temperature higher than T4 or optional T6. The Equipment Protection Level (EPL) is Ga and Db.
- Further to the valid generally accepted rules of technology the EC type-examination certificate and these operating instructions refer to special conditions and further application conditions that must be observed in any case. However, these operating instructions cannot consider all possible conditions and applications completely, and do not replace the specifications valid in each case.

Installation

- At installation and maintenance it is essential to keep to the concerning Ex standards, especially IEC/EN 60079-14.
- After removing the packing, make sure that dirt cannot penetrate into the system.
- Before mounting the system, check that there is no dirt in the piping or the valve housing.
- Make sure not to detach pipes and valves of pressurized systems.
- Take suitable measures to exclude unintentional activation or inadmissible impairment.
- Make sure not to damage o-rings and seals during assembly.
- Mounting is admissible in any position. Preferably the solenoid coil points upwards.
- The solenoid coil can be locked when offset by 45°.
- At choice of the material of the valve bodies must be observed:
 - Casting alloys:
The maximum admissible percent by weight may not exceed the following limits according to the desired Equipment Protection Levels:
Group II EPL Ga: in total 10 % aluminium, magnesium, titanium and zirconium;
Group II EPL Gb and Group III EPL Db: in total 7.5 % magnesium and titanium;
 - Plastics:
In order to avoid the build-up of electrostatic charges the requirements according to IEC/EN 60079-0 section 7.4 must be observed.
- Electrical connection: The connector is part of the equipment must not be removed permanently; otherwise the protection marking becomes void. Note here the necessary and maximum torque of the fixing screw and the tool provided for that.
- The solenoid has to be connected by inserting related intrinsically safe work equipment (e.g. isolating element or barrier) in accordance with the manufacturer's instructions.

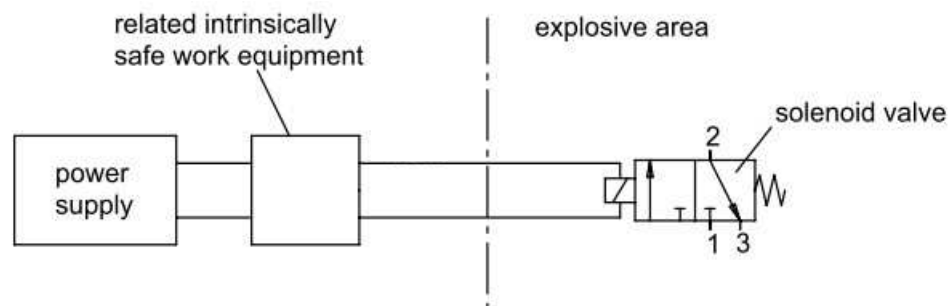

- Connection to a certified intrinsically safe circuit of type of protection:

Ex ia IIC	with maximum values	$U_i = 28 \text{ V}$	$I_i = 115 \text{ mA}$
Ex ia IIB	with maximum values	$U_i = 32 \text{ V}$	$I_i = 195 \text{ mA}$
- The effective inductance and capacitance is negligible low ($L_i \approx 0$, $C_i \approx 0$).

- For ensuring the switching function in the entire temperature range a minimum switch-on current is necessary. At maximum temperature rise of the coil, an equivalent resistance of the coil must be assumed (values see table). In the characteristic diagram have been considered an additional line resistance of 18 Ohm and a series voltage of 1 V, needed for the internal electronics.

circuit diagram

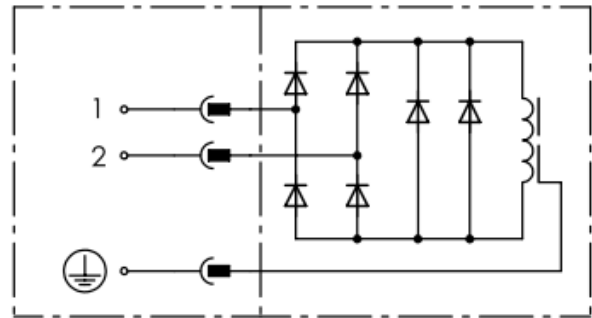

winding W	minimum switch-on current [mA]	nominal resistance [Ω]	equivalent resistance T4 [Ω]	equivalent resistance T6 [Ω]	NW / operating pressure [mm] / [kPa] / [bar]
5146	37	275	385	345	0.8 / 800 / 8
					0.6 / 1000 / 10
7210	27	400	510	455	0.6 / 800 / 8

- As an example, three possible characteristics of supply units are charted below. At interconnection, the units work at the point of intersection of the respective characteristics. The operating point must be on the right side of the characteristic of the minimum switch-on current (in this example 37 mA). In the following example, the results are as follows:
Supply unit X is suited.
Supply unit Y is only suited for T6.
Supply unit Z is not suited.

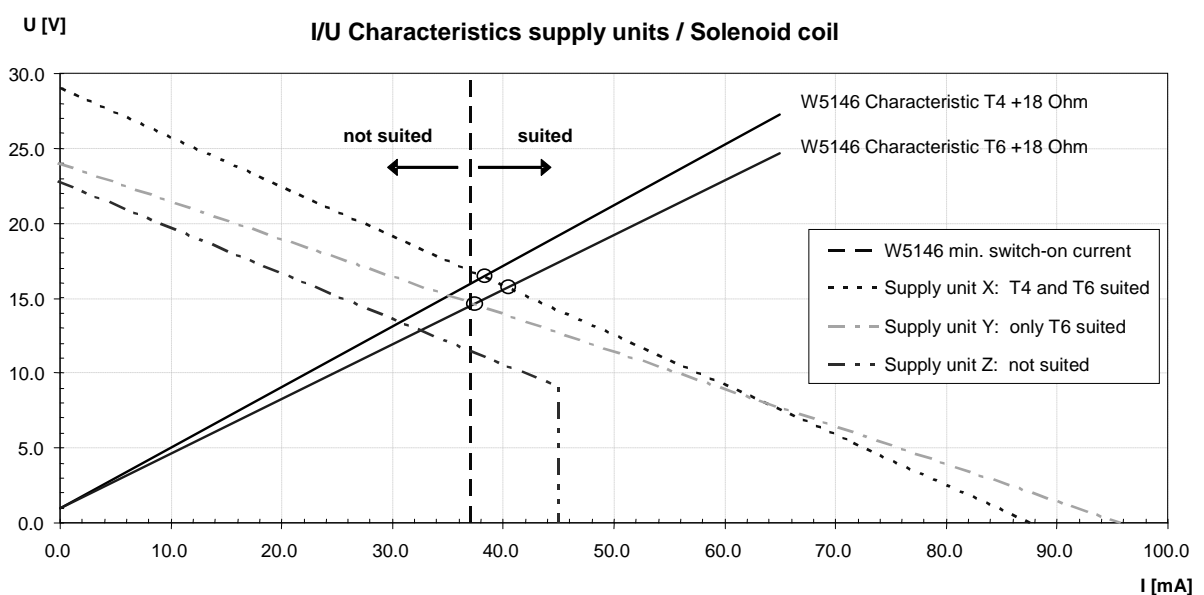

For characteristics of the supply units refer to the supplier's data sheets.

- Before initial operation of the device, make sure that the overall equipment respectively the unit meets the requirements of the applicable EU directives (e.g. the EMC directive).
- Please order spare parts completely by indicating the identification number provided on the units (imprint / type plate).

Operation

- The solenoid operators 1262 00 to 1262 49 of Temperature Class T6 are suitable for the following conditions:
 - Ambient temperature range from -40 °C to +50 °C
 - Maximum admissible media temperature: +70 °C
- The solenoid operators 1262 50 to 1262 99 of Temperature Class T4 are suitable for the following conditions:
 - Ambient temperature range from -40 °C to +85 °C
 - Maximum admissible media temperature: +80 °C
- The solenoid operators are suitable for single and series mounting at a 100% duty cycle.
- **Caution! Risk of injury! The solenoid's surface can get very hot during continuous operation.**
- The device's operating pressure depends on the armature system used. The mass magnet standard armature system is suited for up to 12 bars (1200 kPa) and has no extra identification mark. For operating pressures greater than 12 bars other documents are available.
- Admissible media are gas and liquids that do not affect the system and the gasket material contained therein.
- Prevent the device's exterior surfaces from getting in contact with liquid or corrosive media.
- Do not strain the system by bending or torsion.
- Prevent the connecting cables from being buckled or damaged in order to avoid short circuits and interruptions.

Malfunctions

- Check the cable connections, operating voltage and operating pressure.
- Check for externally visible damage.
- Should the problem persist the device must be put out of operation. Make sure to disconnect pressure and electrical power supply.
- Defective devices must not be repaired but must be replaced. Please order spare parts completely by indicating the identification number provided on the units (imprint / type plate).

Installation scheme

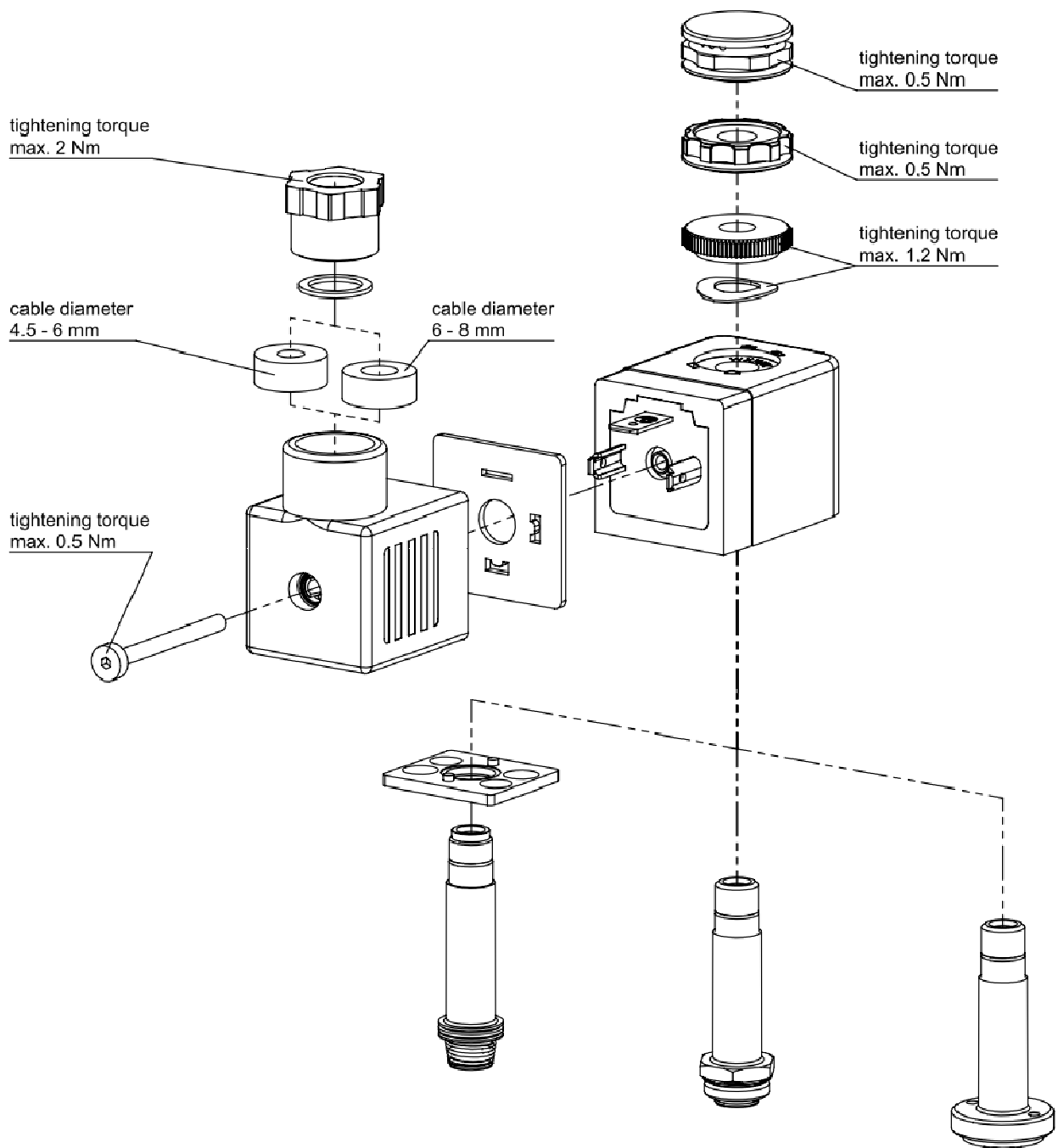



EU Declaration of Conformity

nass magnet GmbH, Hanover, declares and bears sole responsibility for the following products to be in compliance with the safety standards:



Solenoid operator
1262 00 to 1262 49

 II 2 G Ex ia IIC T6 Ga
II 2 G Ex ia IIB T6 Ga
II 2 D Ex tb IIIC T80 °C Db IP65

 Ex ia IIC T6 Ga
 Ex ia IIB T6 Ga
 Ex tb IIIC T80°C Db IP65

Solenoid operator
1262 50 to 1262 99

 II 2 G Ex ia IIC T4 Ga
II 2 G Ex ia IIB T4 Ga
II 2 D Ex tb IIIC T130 °C Db IP65

 Ex ia IIC T4 Ga
 Ex ia IIB T4 Ga
 Ex tb IIIC T130°C Db IP65

The EC type-examination certificate with the number

PTB 09 ATEX 2001 and IECEx PTB 13.0009

issued by Physikalisch Technische Bundesanstalt (registration entity no. 0102) are applicable for the named Ex-products.

The solenoid operator is an encapsulated safe electrical apparatus of Groups IIB, IIC and IIIC, designed for application in atmospheres according to Category 2 G and 2 D, Temperature Class T4 or T6, the Equipment Protection Level (EPL) is Ga and Db.

The device, that bears the CE marking, meets the following standards:

EN 60079-0:2009	Explosive atmospheres - Part 0: Equipment - General requirements
IEC 60079-0:2007 (Ed. 5)	Explosive atmospheres - Part 0: Equipment - General requirements
EN 60079-11:2012	Explosive atmospheres - Part 11: Equipment protection by intrinsic safety "i"
IEC 60079-11:2011 (Ed. 6)	Explosive atmospheres - Part 11: Equipment protection by intrinsic safety "i"
EN 60079-31:2009	Explosive atmospheres - Part 31: Equipment dust ignition protection by enclosure "t"
IEC 60079-31:2008 (Ed. 1)	Explosive atmospheres - Part 31: Equipment dust ignition protection by enclosure "t"
EN 60 529:2000	Degrees of protection provided by enclosures (IP code)
DIN VDE 0580:2011	Electromagnetic devices and components - General specifications
Directive 94/9/EC	Equipment and protective systems intended for use in potentially explosive atmospheres
Directive 2011/65/EU	on the restriction of the use of hazardous substances in electrical and electronic equipment (recast of 8 June 2011)

Thomas Groetzinger
General Manager



Hanover, 01. Nov. 2013